

圖 面 標 準 格 式

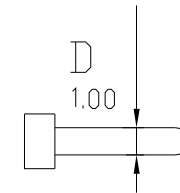
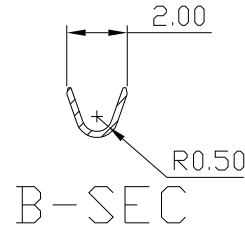
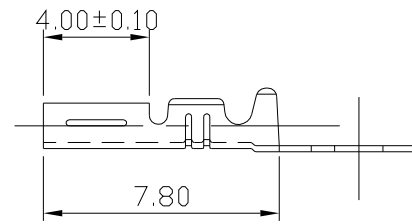
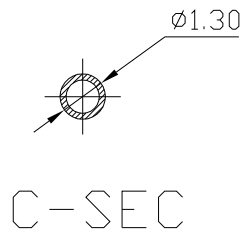
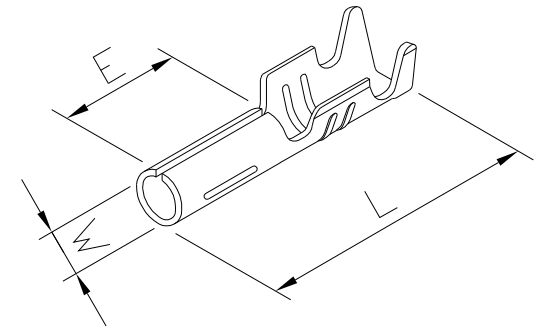
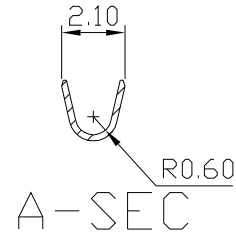
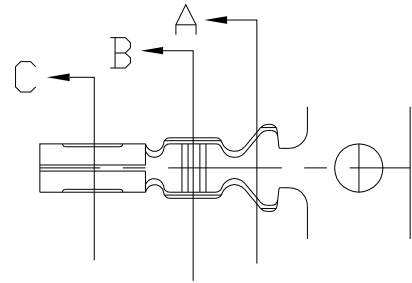

HO TIEN PRECISION INDUSTRY CO., LTD.
合田精密工業股份有限公司

電線規格 / WIRE RANGE AWG : 26-30

RECORD OF REVISION/ 修定內容	REV.BY/ 修定者	REV.DATE/ 修定日期	PART NO./ 品名	3304PS-2	APPROVED BY/ 核准	
			MATERIAL/ 材質	PHOS BRONZE t0.20	CHECKED BY/ 審查	
			TREATMENT/ 表面處理	Ni / Tin	DRAWN/ 繪圖	
			CUSTOMER/ 客戶品名		DATE/ 製圖日期	
			UNIT/ 單位	M/M	SCALE/ 比例	4:1
					DRAWIN TYPE/ 圖面種類	