

圖 面 標 準 格 式

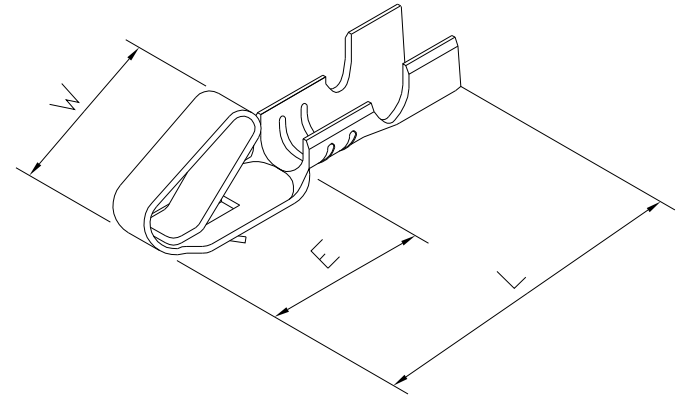
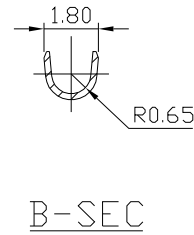
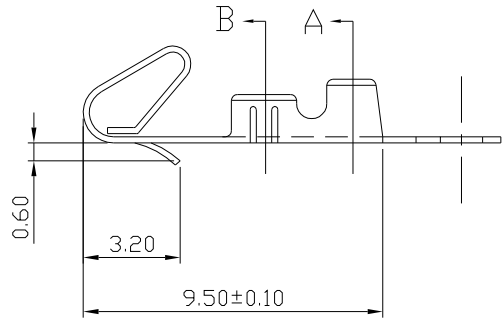
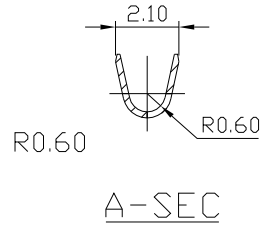
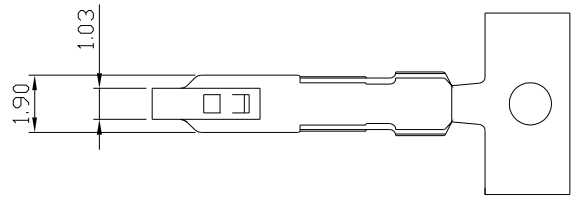

HO TIEN PRECISION INDUSTRY CO., LTD.  
合田精密工業股份有限公司

電線規格 / WIRE RANGE AWG : 24-28

RECORD OF REVISION / 修定內容	REV.BY / 修定者	REV.DATE / 修定日期	PART NO. / 品名	3502BS-2	APPROVED BY / 核准	
			MATERIAL / 材質	BRASS t0.20	CHECKED BY / 審查	
			TREATMENT / 表面處理	Tin	DRAWN / 繪圖	
			CUSTOMER / 客戶品名		DATE / 製圖日期	
			UNIT / 單位	M/M	SCALE / 比例	4:1
					DRAWIN TYPE / 圖面種類	